

OSCILLATION & WAVES

1. INTRODUCTION

- (1) A motion which repeats itself over and over again after a regular interval of time is called a periodic motion.
- (2) Oscillatory or vibratory motion is that motion in which a body moves to and fro or back and forth repeatedly about a fixed point in a definite interval of time.
- (3) Simple harmonic motion is a specific type of oscillatory motion, in which
 - (a) particle moves in one dimension,
 - (b) particle moves to and fro about a fixed mean position (where $F_{\text{net}} = 0$),
 - (c) net force on the particle is always directed towards mean position, and
 - (d) magnitude of net force is always proportional to the displacement of particle from the mean position at that instant.

So, $F_{\text{net}} = -kx$

where, k is known as force constant

$\Rightarrow ma = -kx$

$\Rightarrow a = \frac{-k}{m}x$ or $a = -\omega^2x$

where, ω is known as angular frequency.

$\Rightarrow \frac{d^2x}{dt^2} = -\omega^2x$

This equation is called as the differential equation of S.H.M.

The general expression for $x(t)$ satisfying the above equation is :

$x(t) = A \sin(\omega t + \phi)$

1.1 Some Important terms

1. Amplitude

The amplitude of particle executing S.H.M. is its maximum displacement on either side of the mean position.

A is the amplitude of the particle.

2. Time Period

Time period of a particle executing S.H.M. is the time taken to complete one cycle and is denoted by T .

Time period (T) = $\frac{2\pi}{\omega} = 2\pi\sqrt{\frac{m}{k}}$ as $\omega = \sqrt{\frac{k}{m}}$

3. Frequency

The frequency of a particle executing S.H.M. is equal to the number of oscillations completed in one second.

$v = \frac{\omega}{2\pi} = \frac{1}{2\pi}\sqrt{\frac{k}{m}}$

4. Phase

The phase of particle executing S.H.M. at any instant is its state as regard to its position and direction of motion at that instant. it is measured as argument (angle) of sine in the equation of S.H.M.

Phase = $(\omega t + \phi)$

At $t = 0$, phase = ϕ ; the constant ϕ is called initial phase of the particle or phase constant.

1.2 Important Relations

1. Position

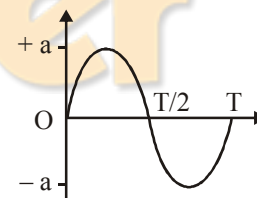

If mean position is at origin the position (X coordinate) depends on time in general as :

$x(t) = \sin(\omega t + \phi)$

- At mean position, $x = 0$
- At extremes, $x = +A, -A$

2. Velocity

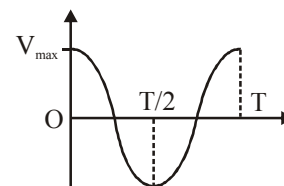

- At any time instant t , $v(t) = A\omega \cos(\omega t + \phi)$

- At any position x , $v(x) = \pm \omega \sqrt{A^2 - x^2}$
- Velocity is minimum at extremes because the particles is at rest.
i.e., $v = 0$ at extreme position.
- Velocity has maximum magnitude at mean position.
 $|v|_{\max} = \omega A$ at mean position.

3. Acceleration

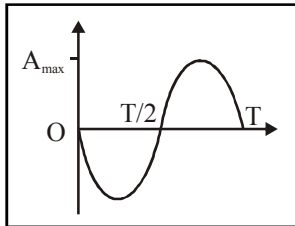

- At any instant t , $a(t) = -\omega^2 A \sin(\omega t + \phi)$
- At any position x , $a(x) = -\omega^2 x$
- Acceleration is always directed towards mean position.
- The magnitude of acceleration is minimum at mean position and maximum at extremes.
 $|a|_{\min} = 0$ at mean position.
 $|a|_{\max} = \omega^2 A$ at extremes.

4. Energy

Kinetic energy

- $$K = \frac{1}{2} mv^2 \Rightarrow K = \frac{1}{2} m\omega^2 (A^2 - x^2)$$
- $$= \frac{1}{2} m\omega^2 A^2 \cos^2(\omega t + \phi)$$

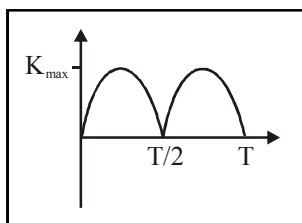

- K is maximum at mean position and minimum at extremes.
- $K_{\max} = \frac{1}{2} m\omega^2 A^2 = \frac{1}{2} kA^2$ at mean position
- $K_{\min} = 0$ at extremes.

Potential Energy

If potential energy is taken as zero at mean position, then at any position x ,

$$U(x) = \frac{1}{2} kx^2 = \frac{1}{2} mA^2\omega^2 \sin^2(\omega t + \phi)$$

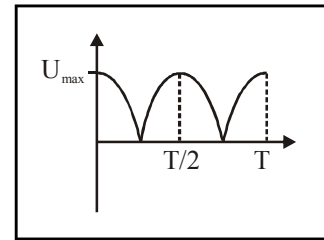

- U is maximum at extremes $U_{\max} = \frac{1}{2} kA^2$
- U is minimum at mean position

Total Energy

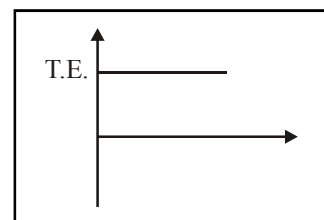

$$T.E. = \frac{1}{2} kA^2 = \frac{1}{2} mA^2\omega^2$$

and is constant at all time instant and at all positions.

Energy position graph

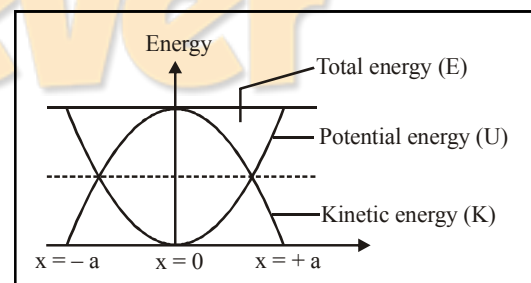

2. TIME PERIOD OF S.H.M.

To find whether a motion is S.H.M. or not and to find its time period, follow these steps :

- Locate the mean (equilibrium) position mathematically by balancing all the forces on it.
- Displace the particle by a displacement 'x' from the mean position in the probable direction of oscillation.
- Find the net force on it and check if it is towards mean position.
- Try to express net force as a proportional function of its displacement 'x'.

- If step (c) and step (d) are proved then it is a simple harmonic motion.
- (e) Find k from expression of net force ($F = -kx$) and find time period using $T = 2\pi\sqrt{\frac{m}{k}}$.

2.1 Oscillations of a Block Connected to a Spring

(a) Horizontal spring:

Let a block of mass m be placed on a smooth horizontal surface and rigidly connected to spring of force constant K whose other end is permanently fixed.

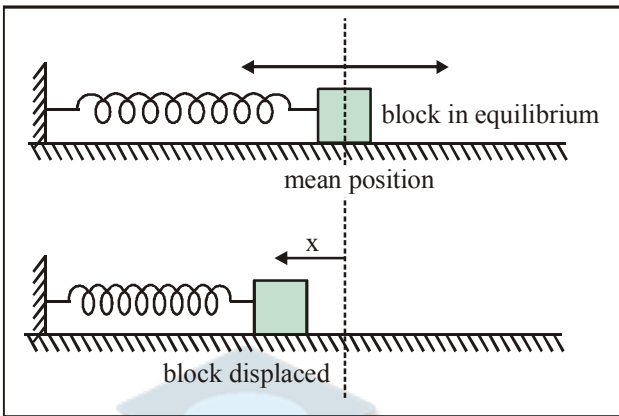

- Mean position : when spring is at its natural length.

- Time period : $T = 2\pi\sqrt{\frac{m}{k}}$

(b) Vertical Spring:

If the spring is suspended vertically from a fixed point and carries the block at its other end as shown, the block will oscillate along the vertical line.

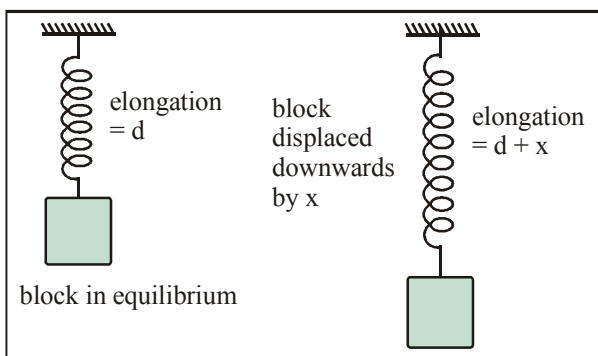

- Mean position : spring is elongated by $d = \frac{mg}{k}$

- Time period : $T = 2\pi\sqrt{\frac{m}{k}}$

(c) Combination of springs :

1. Springs in series

When two springs of force constant K_1 and K_2 are connected in series as shown, they are equivalent to a single spring of force constant K which is given by

$$\frac{1}{K} = \frac{1}{K_1} + \frac{1}{K_2}$$

$$K = \frac{K_1 K_2}{K_1 + K_2}$$

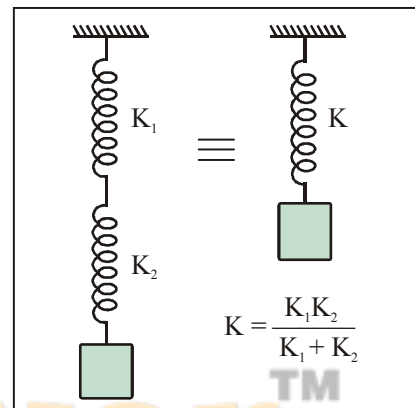

2. Springs in parallel

For a parallel combination as shown, the effective spring constant is $K = K_1 + K_2$

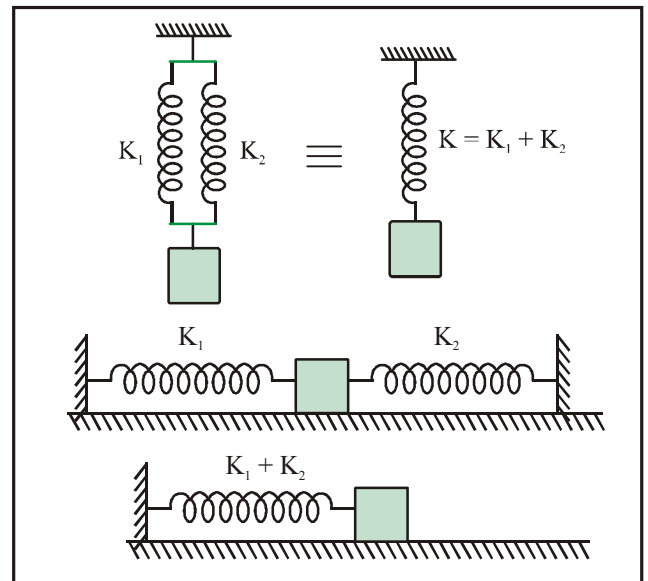

2.2 Oscillation of a Cylinder Floating in a liquid

Let a cylinder of mass m and density d be floating on the surface of a liquid of density ρ . The total length of cylinder is L .

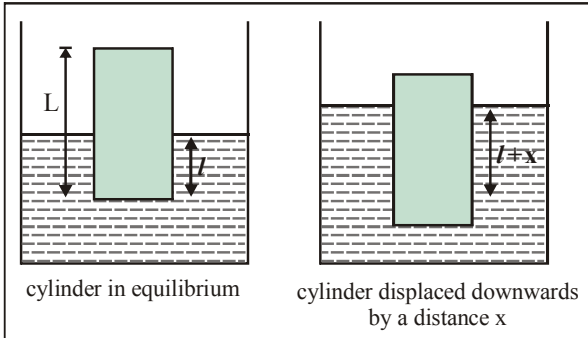

- Mean position : cylinder is immersed upto $\ell = \frac{Ld}{\rho}$
- Time period : $T = 2\pi\sqrt{\frac{Ld}{\rho g}} = 2\pi\sqrt{\frac{\ell}{g}}$

2.3 Liquid Oscillating in a U-Tube

Consider a liquid column of mass m and density ρ in a U-tube of area of cross section A .

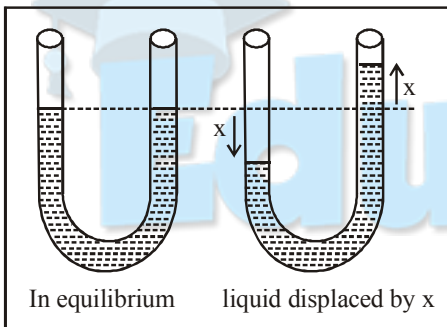

- Mean position : when height of liquid is same in both limbs.
- Time period : $T = 2\pi\sqrt{\frac{m}{2A\rho g}} = 2\pi\sqrt{\frac{L}{2g}}$
where, L is length of liquid column.

2.4 Body Oscillation in tunnel along any chord of earth

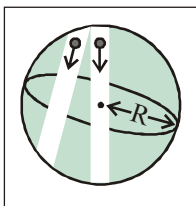

- Mean position : At the centre of the chord

- Time period : $T = 2\pi\sqrt{\frac{R}{g}} = 84.6$ minutes
where, R is radius of earth.

2.5 Angular Oscillations

Instead of straight line motion, if a particle or centre of mass of a body is oscillating on a small arc of circular path then it is called angular S.H.M.

For angular S.H.M., $\tau = -k\theta$

$\Rightarrow I\alpha = -k\theta$

\Rightarrow Time period, $T = 2\pi\sqrt{\frac{I}{k}}$

2.5.1 Simple Pendulum

- Time period : $T = 2\pi\sqrt{\frac{\ell}{g}}$
- Time period of a pendulum in a lift :
 $T = 2\pi\sqrt{\frac{\ell}{g+a}}$ (if acceleration of lift is upwards)
 $T = 2\pi\sqrt{\frac{\ell}{g-a}}$ (if acceleration of lift is downwards)
- Second's pendulum
Time period of second's pendulum is 2s.
Length of second's pendulum on earth surface ≈ 1 m.

2.5.2 Physical Pendulum

Time period : $T = 2\pi\sqrt{\frac{I}{mg\ell}}$

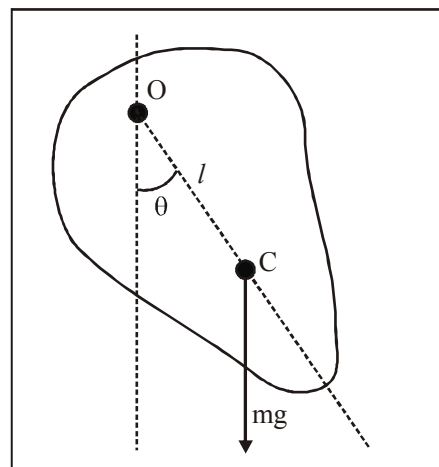

where, I is moment of inertia of object about point of suspension, and

l is distance of centre of mass of object from point of suspension.

3. DAMPED AND FORCED OSCILLATIONS

1. Damped Oscillation :

- (i) The oscillation of a body whose amplitude goes on decreasing with time is defined as damped oscillation.
- (ii) In this oscillation the amplitude of oscillation decreases exponentially due to damping forces like frictional force, viscous force etc.

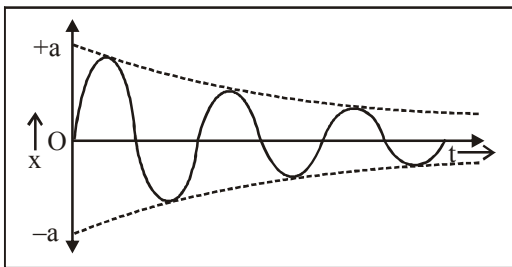

- (iii) Due to decrease in amplitude the energy of the oscillator also goes on decreasing exponentially.

2. Forced Oscillation :

- (i) The oscillation in which a body oscillates under the influence of an external periodic force are known as forced oscillation.
- (ii) Resonance : When the frequency of external force is equal to the natural frequency of the oscillator, then this state is known as the state of resonance. And this frequency is known as resonant frequency.

4. WAVES

(a) Speed of longitudinal wave

- Speed of longitudinal wave in a medium is given by

$$v = \sqrt{\frac{E}{\rho}}$$

where, E is the modulus of elasticity,

ρ is the density of the medium.

- Speed of longitudinal wave in a solid in the form of rod is given by

$$v = \sqrt{\frac{Y}{\rho}}$$

where, Y is the Young's modulus of the solid,

ρ is the density of the solid.

- Speed of longitudinal wave in fluid is given by

$$v = \sqrt{\frac{B}{\rho}}$$

where, B is the bulk modulus,

ρ is the density of the fluid.

(b) Newton's formula

- Newton assumed that propagation of sound wave in gas is an isothermal process. Therefore, according to

Newton, speed of sound in gas is given by $v = \sqrt{\frac{P}{\rho}}$

where P is the pressure of the gas and ρ is the density of the gas.

- According to the Newton's formula, the speed of sound in air at S.T.P. is 280 m/s. But the experimental value of⁻¹. Newton could not explain this large difference. Newton's formula was corrected by Laplace.

(c) Laplace's correction

- Laplace assumed that propagation of sound wave in gas in an adiabatic process. Therefore, according to Laplace, speed of sound in a gas is given by

$$v = \sqrt{\frac{\gamma P}{\rho}}$$

- According to Laplace's correction the speed of sound in air at S.T.P. is 331.3 m/s. This value agrees fairly well with the experimental values of the velocity of sound in air at S.T.P.

5. WAVES TRAVELLING IN OPPOSITE DIRECTIONS

- When two waves of same amplitude and frequency travelling in opposite directions

$$y_1 = A \sin(kx - \omega t)$$

$$y_2 = A \sin(kx + \omega t)$$

interfere, then a standing wave is produced which is given by,

$$y = y_1 + y_2$$

$$\Rightarrow y = 2A \sin kx \cos \omega t$$

- Hence the particle at location x is oscillating in S.H.M. with angular frequency ω and amplitude $2A \sin kx$. As the amplitude depends on location (x), particles are oscillating with different amplitude.

OSCILLATION AND WAVES

- **Nodes :** Amplitude = 0
 $2A \sin kx = 0$
 $x = 0, \pi/k, 2\pi/k, \dots$
 $x = 0, \lambda/2, \lambda, 3\lambda/2, 2\lambda, \dots$
- **Antinodes :** Amplitude is maximum.
 $\sin kx = \pm 1$
 $x = \pi/2k, 3\pi/2k$
 $x = \lambda/4, 3\lambda/4, 5\lambda/4$

- Nodes are completely at rest. Antinodes are oscillating with maximum amplitude (2A). The points between a node and antinode have amplitude between 0 and 2A.
- Separation between two consecutive (or antinodes) = $\lambda/2$.
- Separation between a node and the next antinode = $\lambda/4$.
- Nodes and antinodes are alternately placed.

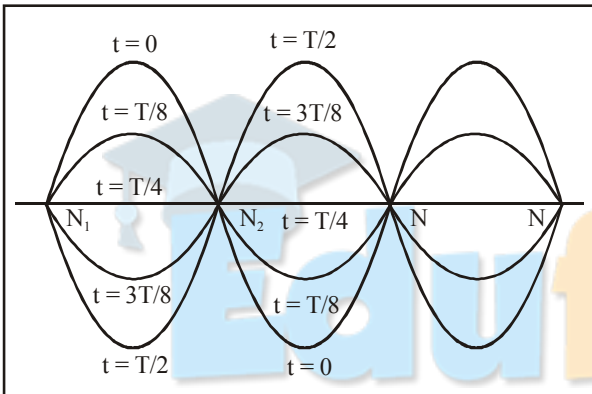

- It is clear from the figure that since nodes are, at rest they don't transfer energy. In a stationary wave, energy is not transferred from one point to the other.

5.1 Vibrations in a stretched string

- Fixed at both ends.**
 - Transverse standing waves with nodes at both ends of the string are formed.
 - So, length of string, $\ell = \frac{n\lambda}{2}$ if there are (n + 1) nodes and n antinodes.
 - Frequency of oscillations is

$$\Rightarrow v = \frac{v}{\lambda} = \frac{nv}{2\ell}$$

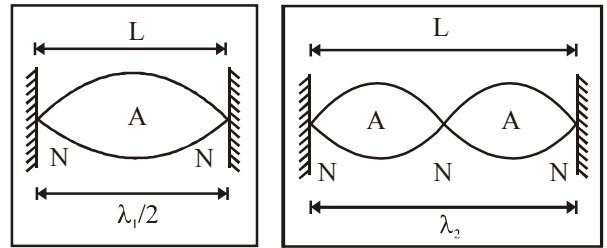

- Fundamental frequency (x = 1)
 $v_0 = \frac{v}{2L}$
 It is also called first harmonic.
- Second harmonic or first overtone
 $v = \frac{2v}{2L}$
- The nth multiple of fundamental frequency is known as nth harmonic or (n - 1)th overtone.

2. Fixed at one end

- Transverse standing waves with node at fixed end and antinode at open end are formed.
- So, length of string $\ell = (2n - 1) \frac{\lambda}{4}$ if there are n nodes and n antinodes.

- Frequency of oscillations

$$\Rightarrow v = \frac{v}{\lambda} = \frac{(2n - 1)v}{4\ell}$$

- Fundamental frequency, (n = 1)

$$v_0 = \frac{v}{4L}$$

It is also called first harmonic.

- First overtone or third harmonic.

$$v = \frac{3v}{4\ell} = 3v_0$$

- Only odd harmonics are possible in this case.

5.2 Vibrations in an organ pipe

1. Open Organ pipe (both ends open)

- The open ends of the tube becomes antinodes because the particles at the open end can oscillate freely.
- If there are (n + 1) antinodes in all,

length of tube, $\ell = \frac{n\lambda}{2}$

- So, Frequency of oscillations is $\nu = \frac{nv}{2\ell}$

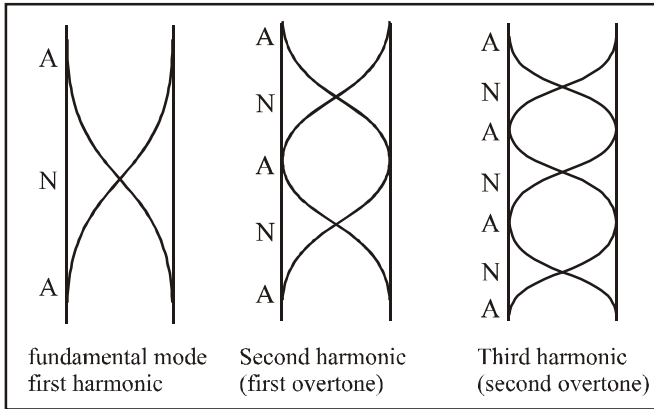

2. Closed organ pipe (One end closed)

- The open end becomes antinode and closed end become a node.
- If there are n nodes and n antinodes,
 $L = (2n - 1) \lambda/4$
- So frequency of oscillations is

$$\nu = \frac{v}{\lambda} = \frac{(2n-1)v}{4L}$$

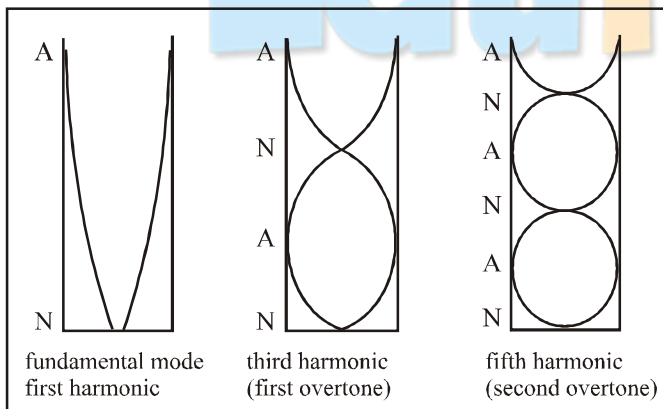

- There are only odd harmonics in a tube closed at one end.

5.3 Waves having different frequencies

Beats are formed by the superposition of two waves of slightly different frequencies moving in the same direction. The resultant effect heard in this case at any fixed position will consist of alternate loud and weak sounds.

Let us consider net effect of two waves of frequencies ν_1 and ν_2 and amplitude A at $x = 0$.

$$y_1 = A \sin 2\pi\nu_1 t$$

$$y_2 = A \sin 2\pi\nu_2 t$$

$$\Rightarrow y = y_1 + y_2$$

$$\Rightarrow y = A (\sin 2\pi\nu_1 t + \sin 2\pi\nu_2 t)$$

$$y = [2A \cos \pi(\nu_1 - \nu_2) t] \sin \pi(\nu_1 + \nu_2) t$$

Thus the resultant wave can be represented as a travelling wave whose frequency is $\left(\frac{\nu_1 + \nu_2}{2}\right)$ and amplitude is $2A \cos \pi(\nu_1 - \nu_2) t$.

As the amplitude term contains t, the amplitude varies periodically with time.

For Loud Sounds : Net amplitude = $\pm 2A$

$$\Rightarrow \cos \pi(\nu_1 - \nu_2) t = \pm 1$$

$$\Rightarrow \pi(\nu_1 - \nu_2) t = 0, \pi, 2\pi, 3\pi \dots\dots$$

$$\Rightarrow t = 0, \frac{1}{\nu_1 - \nu_2}, \frac{2}{\nu_1 - \nu_2} \dots\dots$$

Hence the interval between two loud sounds is given as :

$$= \frac{1}{\nu_1 - \nu_2}$$

$$\Rightarrow \text{the number of loud sounds per second} = \nu_1 - \nu_2$$

$$\Rightarrow \text{beat per second} = \nu_1 - \nu_2$$

Note that $\nu_1 - \nu_2$ must be small (0 – 16 Hz) so that sound variations can be distinguished.

Note..

- Filling a tuning fork increases its frequency of vibration.
- Loading a tuning fork decreases its frequency of vibration.

6. DOPPLER EFFECT

According to Doppler's effect, whenever there is a relative motion between a source of sound and listener, the apparent frequency of sound heard by the listener is different from the actual frequency of sound emitted by the source.

Apparent frequency,

$$\nu' = \frac{\nu - \nu_L}{\nu - \nu_s} \times \nu$$

Sing Convention. All velocities along the direction S to L are taken as positive and all velocities along the direction L to S are taken as negative.

When the motion is along some other direction the component of velocity of source and listener along the line joining the source and listener is considered.

Special Cases :

- (a) If the source is moving towards the listener but the listener is at rest, then v_s is positive and $v_L = 0$ (figure a). Therefore,

$$v' = \frac{v}{v - v_s} \times v \quad \text{i.e. } v' > v$$

- (b) If the source is moving away from the listener, but the listener is at rest, then v_s is negative and $v_L = 0$ (figure b). Therefore,

$$v' = \frac{v}{v - (-v_s)} \times v = \frac{v}{v + v_s} \times v \quad \text{i.e. } v' < v$$

- (c) If the source is at rest and listener is moving away from the source, the $v_s = 0$ and v_L is positive (figure c). Therefore,

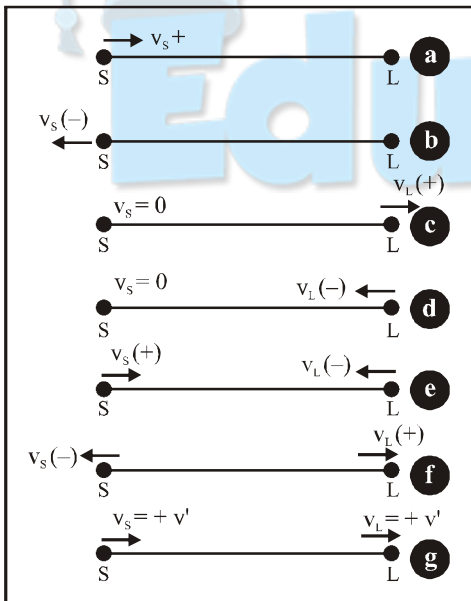

$$v' = \frac{(v - v_L)}{v} \times v \quad \text{i.e. } v' < v$$

- (d) If the source is at rest and listener is moving towards the source, then $v_s = 0$ and v_L is negative (figure d). Therefore,

$$v' = \frac{v - (-v_L)}{v} \times v = \frac{v + v_L}{v} \times v \quad \text{i.e. } v' > v$$

- (e) If the source and listener are approaching each other, then v_s is positive and v_L is negative (figure e). Therefore,

$$v' = \frac{v - (-v_L)}{v - v_s} \times v = \left(\frac{v + v_L}{v - v_s} \right) \times v \quad \text{i.e. } v' > v$$

- (f) If the source and listener are moving away from each other, then v_s is negative and v_L is positive, (figure f). Therefore,

$$v' = \frac{v - v_L}{v - (-v_s)} \times v = \frac{v - v_L}{v + v_s} \times v \quad \text{i.e. } v' < v$$

- (g) If the source and listener are both in motion in the same direction and with same velocity, then $v_s = v_L = v'$ (say) (figure g). Therefore,

$$v' = \frac{(v - v')}{(v - v')} \times v \quad \text{i.e. } v' = v$$

It means, there is no change in the frequency of sound heard by the listener.

Apparent wavelength heard by the observer is

$$\lambda' = \frac{v - v_s}{v}$$

Note.. If case the medium is also moving, the speed of sound with respect to ground is considered. i.e. $\vec{v} + \vec{v}_m$

7. CHARACTERISTICS OF SOUND

- **Loudness** of sound is also called level of intensity of sound.

In decibel the loudness of a sound of intensity I is

$$\text{given by } L = 10 \log_{10} \left(\frac{I}{I_0} \right). \quad (I_0 = 10^{-12} \text{ w/m}^2)$$

- **Pitch** : It is pitch depends on frequency, higher the frequency higher will be the pitch and shriller will be the sound.